

PCL Series Electromagnetic Flowmeters



Introduction

PCL series electromagnetic flowmeters, composed of sensor and converter, work based on Faraday's law of electromagnetic induction. It is used to measure electrical conductivity of liquid or solid. Generally, the electrical conductivity should be over 5uS/cm (electrical conductivity of tap water, raw water is about 100-500uS/cm. It can also be used to measure various mediums like acid, alkali, saline solution, paper pulp, ore pulp and so on, but these mediums cannot contain a lot of magnetic materials and bubbles.

Working principle

The principle of the sensor is based on Faraday's law of electromagnetic induction. It is installed a pair of detection electrodes on the pipe wall, where the measurement pipe axis and magnetic field lines are vertical. When the conductive liquid moves along the measurement pipe axis, the conductive liquid cuts magnetic field lines and produces induced electromotive force, which can be measured by the two electrodes on the meter pipe. The result can be calculated by the formula:

$$E=KB\bar{V}D$$

E-Induced electromotive force

K-Meter constant

B-Magnetic flux density



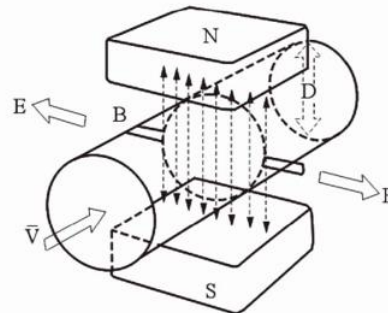

V-Average velocity of pipe section

D-Internal diameter of measuring pipe



When measuring flow, fluid flows through magnetic field which is perpendicular to the direction of the flow. Then the flow of conductive fluid induces electromotive force proportional to the average velocity. Therefore, the detected fluid requires to be higher than the minimum of electrical conductivity. Its induced voltage signal is detected through two electrodes and sent to a converter through the cable. After signal processing and related operations, PCL electromagnetic flowmeter will display total flow and instantaneous flow in converter display.

Specifications

PCL Electromagnetic Flowmeter										
	Divided type		Integrated type (IP67)		Integrated type with explosion proof		Battery type		Heat (Energy) type	
Basic error	±0.2% or ±0.5% of indicated value									
Diameter(mm)	DN15-DN2400				DN15-DN600			DN25-DN1400		
Flange	Comply with GB9119 standard, Carbon steel (Stainless steel optional)									
Pressure level	DN15-DN600 1.0, 1.6, 2.5, 4.0MPa				DN15-DN600 1.0, 1.6, 2.5, 4.0Mpa			DN15-DN600 1.0, 1.6, 2.5, 4.0MPa		
	DN700-DN2400 0.6, 1.0, 1.6MPa							DN700-DN2400 0.6, 1.0, 1.6MPa		
	For special pressure please consult with the manufacturer.									
Lining material	PTFE, PU, CR, PFA, F46, IR									
Conductivity	≥5uS/cm (For <5uS/cm please consult with the manufacturer)									
Electrode	316L, Hastelloy, titanium, tantalum, platinum iridium alloy									
	Temperature sensor type: PT1000									
Protection	IP67 (IP68 optional for sensor)		IP65, IP67		IP65, IP67		IP68		IP67, IP68	
Medium temp.	-25°C-180°C (Refer to the choice of lining material.)		-25°C-80°C (Refer to the choice of lining material.)						-25°C-180°C (Refer to the choice of lining material.)	
Ambient temp. and the influence	-25°C-60°C <±0.1%/10°C or <±0.25%/10°C									
Repetition	≤±0.1%, ±0.25%									
Analog output error	≤±0.02mA									
Measuring range velocity	≤20m/s									
Electrical connection	M20x1.5 seal, G1/2, NPT1/2									
Output	Standard output (4-20mA), Pulse, RS485, HART, Profibus-PA									

Dimension of converter

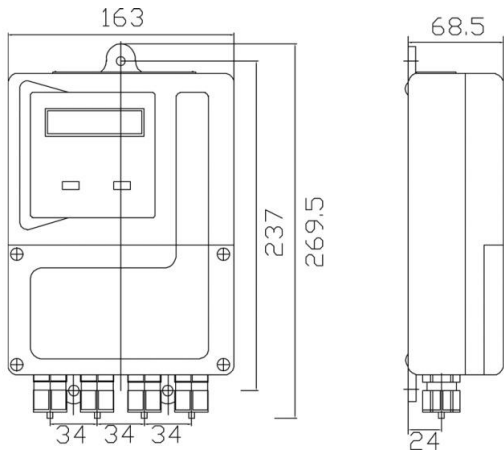

Divided type

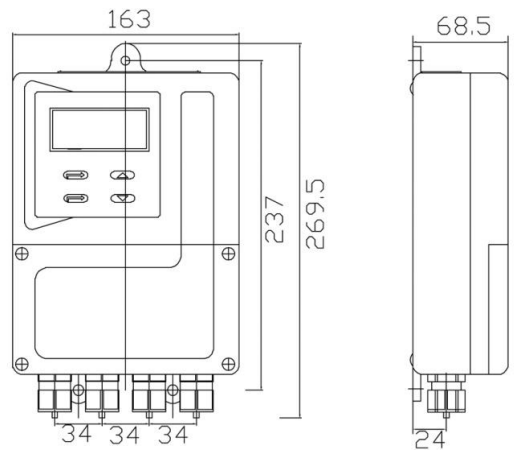

Divided type

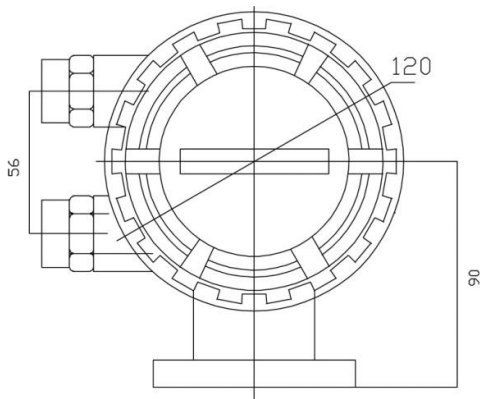

Integrated type

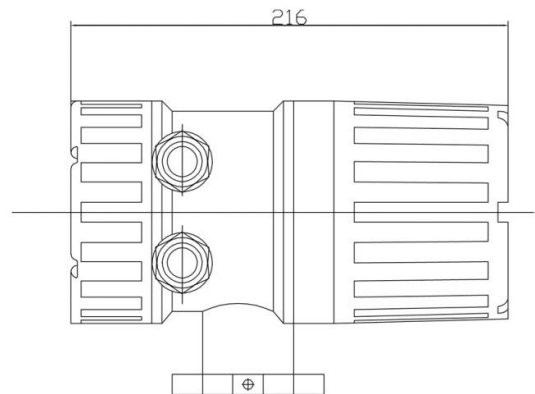

Integrated type

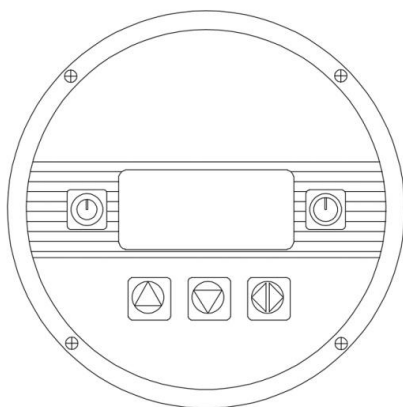

Battery type

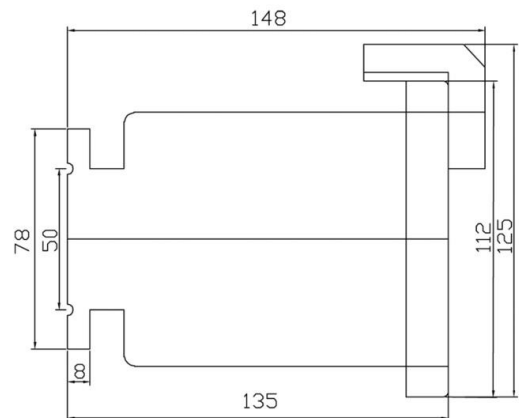

Battery type

(Subject to product manual)

Dimension of sensor

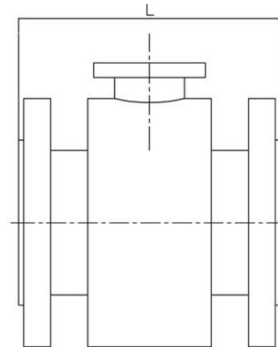
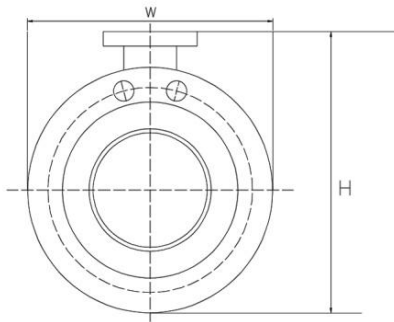

(Subject to product manual)

Diameter (mm)	Dimension (mm)		
	L	W	H
15	160	95	127
20	160	95	137
25	160	115	147
32	160	115	155
40	195	150	165
50	195	165	187
65	195	185	202
80	195	200	223
100	245	220	249
125	245	250	278
150	295	285	303
200	345	340	358
250	395	395	418
300	500	445	468
350	500	505	560
400	600	640	614
450	600	670	656
500	600	670	710
600	600	780	810
700	700	895	995
800	800	1015	1115
900	900	1115	1215
1000	1000	1230	1350
1200	1200	1405	1505

(Data table for reference only)

Lining material should be chosen according to the erosion, abrasion and temperature of measuring medium. The applicability of common lining materials are as follows.

Lining Material	Main Properties	Scope of Application
CR	<ol style="list-style-type: none"> 1. Oil proof, solvent resistance, and resist the erosion of common medium such as acid, alkali, salt, etc. 	<ol style="list-style-type: none"> 1. 0°C-80°C non-strong acid, non-strong alkali and non-strong oxidized medium 2. Be able to measure sewage and mud
IR	<ol style="list-style-type: none"> 1. Good abrasive resistance, corrosion resistance, insulativity, cold resistance 2. Low oil proof, aging resistance, oxidative resistance 	<ol style="list-style-type: none"> 1. -10°C-70°C non-strong acid, non-strong alkali and non-strong oxidized medium; suitable for drinking water
PU	<ol style="list-style-type: none"> 1. Very good abrasive resistance and flexibility 2. Low acid and alkali resistance 	<ol style="list-style-type: none"> 1. -25°C-60°C 2. Ore pulp, coal slurry and mud with neutral strong abrasive resistance
PFA	<ol style="list-style-type: none"> 1. Good hydrophobicity, non-viscousness and thermostability 2. Great corrosion resistance, can resist strong acid, strong alkali, organic solvent and all saline solution 3. Good negative pressure resistance, which can be increased by adding metal net inside 4. Low abrasion resistance 	<ol style="list-style-type: none"> 1. -25°C-140°C non-strong abrasion resistance medium 2. Healthcare medium
PTFE	<ol style="list-style-type: none"> 1. Have the most stable chemical properties in plastics, and can resist boiling hydrochloric acid, sulfuric acid, nitric acid, aqua regia, strong alkali and all kinds of organic solvents, but cannot resist the corrosion of chlorine trifluoride, high temperature nitrogen trifluoride, liquid fluorine, liquid oxygen and ozone 2. Low abrasion resistance 3. Low negative pressure resistance 	<ol style="list-style-type: none"> 1. -25°C-140°C 2. Strong corrosion medium such as strong acid and alkali 3. Healthcare medium
FEP(F46)	<ol style="list-style-type: none"> 1. Hydrophobic and non-viscous 2. Corrosion resistance is inferior to PFA 3. Negative pressure resistance can be increased by adding metal net inside. 4. Low abrasion resistance 	<ol style="list-style-type: none"> 1. -25°C-100°C non-strong abrasion resistance medium 2. Healthcare medium

Electrode material should be selected according to the corrosion resistance of the measuring medium.

Electrode Material	Main Properties
316L	Measure the medium such as water, sewage or inorganic acid, organic acid with slight corrosion.
HC	Resist the corrosion of oxidizing acid, such as nitric acid and mixed medium of chromic acid and sulfuric acid, and oxidative hydrochloric acid, such as Fe ⁺⁺⁺ , Cu ⁺⁺ and some other oxidants, such as sub-argon salt solution higher than normal temperature and oily water.
Ti	Resist the corrosion of salt water, various oxides, hypochlorite, oxidizing acid (including fuming sulfuric acid, nitric acid), organic acid, alkali and so on. It is not resistant to the corrosion of pure reductive acids such as sulfuric acid and hydrochloric acid, but if oxidizing agents are contained in acid, the corrosion is greatly reduced.
Ta	Have good corrosion resistance similar to glass. Resist the corrosion of almost all chemical medium, except hydrofluoric acid, fuming sulfuric acid and alkali. Sodium hydroxide and other alkaline solutions are not applicable.
Pt-Ir	Have good corrosion resistance of all acid, and can resist the corrosion of alkali and all salt.

Ground ring selection

The inductive signal voltage of electromagnetic flowmeter is low, so it is easy to be affected by outside noise or other electromagnetic signals. The function of ground ring is to form a space to shield outside interference so as to increase the accuracy by grounding the body of flowmeter. (The ground ring is required when you use non-metal pipe.) Installation methods in different conditions are as follows.

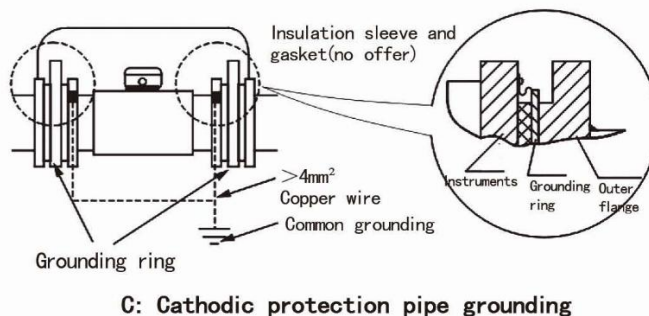
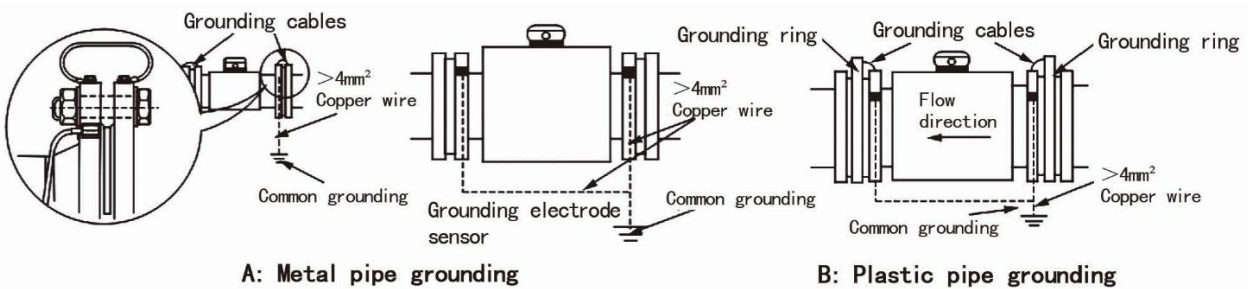

Model: PCL

Installation form	-S	Flange type sensor
	-D	Clamp type sensor
	-C	Insertion type
Pipe diameter	15	15mm
	20	20mm
	25	25mm
	...	
	1200	1200mm
Electrode form	-F	Standard fixed type
Electrode material	A	Stainless steel 316L
	B	Hb
	C	Ta
	D	Ti
	E	Hc
	F	Tungsten carbide
	G	Other _____
Lining material	R	CR
	P	PTFE
	O	Other _____
Measuring pipe material	B	Stainless steel 304(standard)
	C	Stainless steel 316L
Flange material	A	Stainless steel 304
	B	Stainless steel 316L
	C	Carbon steel 20#
Cover plate material	D	Stainless steel 304
	E	Stainless steel 316L
	F	Carbon steel baking finish(Epoxy metallic paint)
Installation supporting flange	0	Without supporting flange
	1	With supporting flange
Ground ring	0	Without ground ring
	1	With ground ring
Rated pressure	-10	1.0MPa
	-16	1.6MPa
	-40	4.0MPa
Medium temperature	E	≤60°C
	H	≤180°C(Divided type)
Converter type	-I	Integrated type
	-D	Divided type
Output signal & communication	P	Pulse
	A	4-20mA
	J	485 communication
	H	HART communication protocol
	Q	Other _____
Power supply	0	220V AC
	1	24V DC
	2	Battery
Protection	0	IP65
	1	IP67(Divided type)
	2	IP68(Divided type)
Other function	R	Heat(Energy) type
	P	With PT1000
	B	Without PT1000
	S	Alarm output, up to 2
	X	Protocol measurement type
	F	Time-sharing type
D	Quantity control type	
Y	Prepaid quantity control type	
Ex-proof	0	Non-explosion proof
	EX	Flameproof

Appendix

Pipe diameter/Flow velocity/Flow comparison table

(DN)	Flow rate m ³ /h																	
	0.4m/s	0.6m/s	0.8m/s	1.0m/s	1.2m/s	1.4m/s	1.6m/s	1.8m/s	2.0m/s	2.2m/s	2.4m/s	2.6m/s	2.8m/s	3.0m/s	4m/s	5m/s	6m/s	7m/s
15	0.25	0.38	0.51	0.64	0.76	0.89	1.02	1.14	1.27	1.40	1.53	1.65	1.78	1.91	2.54	3.18	3.82	4.45
20	0.45	0.68	0.90	1.13	1.36	1.58	1.81	2.03	2.26	2.49	2.71	2.94	3.17	3.39	4.52	5.65	6.78	7.91
25	0.71	1.06	1.41	1.77	2.12	2.47	2.83	3.18	3.53	3.89	4.24	4.59	4.95	5.30	7.07	8.83	10.60	12.36
32	1.16	1.74	2.32	2.89	3.47	4.05	4.63	5.21	5.79	6.37	6.95	7.52	8.10	8.68	11.58	14.47	17.36	20.26
40	1.81	2.71	3.62	4.52	5.43	6.33	7.23	8.14	9.04	9.95	10.85	11.76	12.66	13.56	18.09	22.61	27.13	31.65
50	2.83	4.24	5.65	7.07	8.48	9.89	11.30	12.72	14.13	15.54	16.96	18.37	19.78	21.20	28.26	35.33	42.39	49.46
65	4.78	7.16	9.55	11.94	14.33	16.72	19.10	21.49	23.88	26.27	28.66	31.04	33.43	35.82	47.76	59.70	71.64	83.58
80	7.23	10.85	14.47	18.09	21.70	25.32	28.94	32.56	36.17	39.79	43.41	47.02	50.64	54.26	72.35	90.43	108.52	126.60
100	11.30	16.96	22.61	28.26	33.91	39.56	45.22	50.87	56.52	62.17	67.82	73.48	79.13	84.78	113.04	141.30	169.56	197.82
125	17.66	26.49	35.33	44.16	52.99	61.82	70.65	79.48	88.31	97.14	105.98	114.81	123.64	132.47	176.63	220.78	264.94	309.09
150	25.43	38.15	50.87	63.59	76.30	89.02	101.74	114.45	127.17	139.89	152.60	165.32	178.04	190.76	254.34	317.93	381.51	445.10
200	45.22	67.82	90.43	113.04	135.65	158.26	180.86	203.47	226.08	248.69	271.30	293.90	316.51	339.12	452.16	565.20	678.24	791.28
250	70.65	105.98	141.30	176.63	211.95	247.28	282.60	317.93	353.25	388.58	423.90	459.23	494.55	529.88	706.50	883.13	1059.75	1236.38
300	101.74	152.60	203.47	254.34	305.21	356.08	406.94	457.81	508.68	559.55	610.42	661.28	712.15	763.02	1017.36	1271.70	1526.04	1780.38
350	138.47	207.71	276.95	346.19	415.42	484.66	553.90	623.13	692.37	761.61	830.84	900.08	969.32	1038.56	1384.74	1730.93	2077.11	2423.30
400	180.86	271.30	361.73	452.16	542.59	633.02	723.46	813.89	904.32	994.75	1085.18	1175.62	1266.05	1356.48	1808.64	2260.80	2712.96	3165.12
450	228.91	343.36	457.81	572.27	686.72	801.17	915.62	1030.08	1144.53	1258.98	1373.44	1487.89	1602.34	1716.80	2289.06	2861.33	3433.59	4005.86
500	282.60	423.90	565.20	706.50	847.80	989.10	1130.40	1271.70	1413.00	1554.30	1695.60	1836.90	1978.20	2119.50	2826.00	3532.50	4239.00	4945.50
600	406.94	610.42	813.89	1017.36	1220.83	1424.30	1627.78	1831.25	2034.72	2238.19	2441.66	2645.14	2848.61	3052.08	4069.44	5086.80	6104.16	7121.52



Wotian reserves the right to make any change in this publication without notice. The information provided is believed to be accurate and reliable as of this product sheet.

Contact us

Nanjing Wotian Technology Co.,Ltd.

Add: 5 Wenyong Road, Binjiang Development Zone, Nanjing, 211161, China

Sales Manager: Wuzhou Lian

MP: 0086-13998828452

Email: lianwuzhou@wtsensorus.com